

Application of Laminar Flow Control to Large Military Transports

Charles E. Jobe

Air Force Flight Dynamics Laboratory, Wright-Patterson AFB, Ohio

and

Robert M. Kulfan and John D. Vachal

The Boeing Commercial Airplane Company, Seattle, Wash.

Reprinted from **Journal of AIRCRAFT**

Volume 16, Number 3, March 1979, Pages 170-176

Application of Laminar Flow Control to Large Military Transports

Charles E. Jobe*

Air Force Flight Dynamics Laboratory, Wright-Patterson AFB, Ohio
and

Robert M. Kulfan† and John D. Vachal‡

The Boeing Commercial Airplane Company, Seattle, Wash.

A study of performance increase that could result from applying advanced aerodynamic concepts to large, long-range military transport aircraft showed that laminar flow control (LFC) offered the largest potential. A more in-depth design study then investigated the impact of LFC on the performance, weight, fuel consumption, and economics of a military transport designed to carry 350,000 lb 10,000 nmi. The design study identifies the optimum wing planform and cruise speed, the relative performance increases from different amounts of LFC, and sensitivities to the major LFC uncertainty items; i.e., increased systems weight, complexity, and maintenance, which can only be quantified by design, development, and flight test.

Introduction

Recognizing the impact of fuel shortages and sharp fuel price increases due to the oil embargo, the Air Force Flight Dynamics Laboratory reinitiated work on application of boundary-layer control to large, long-range military transport aircraft in late 1973. Separately and concurrently, NASA Langley began studies of the application of laminar flow control (LFC) to civil passenger transport aircraft that led to the LFC element of the NASA Aircraft Energy Efficient (ACEE) program. The Air Force solicitation resulted in two study contracts with the Boeing Commercial Airplane Company. This paper summarizes results of the initial study to evaluate the application of advanced aerodynamic concepts to large subsonic transport planes,¹ and presents the follow-on preliminary design study that investigated the impact of the application of LFC on the performance, weight, fuel consumption, and economics of a large military transport airplane.² A reference conventional or baseline aircraft was developed during each study to provide consistent comparisons with the advanced aerodynamic technology, LFC aircraft. The technologies considered are representative of a post-1990 initial operational capability (IOC).

The selected baseline strategic airlift mission represents an environment where fuel and refueling bases are not available enroute to or on arrival at a Mideast deployment point. These considerations resulted in a design range of 10,000 nmi. The payload and cargo-box size were determined by the desire to transport approximate weight multiples of main battle tanks or large missiles, and military outsize cargo requirements. The takeoff field length was set at 9000 ft to permit landing at a majority of available terminals with conventional concrete runways. Additional constraints were: ability to carry cargo pallets or containers, drive-through capability, and a pressurized cargo compartment.

Results of the initial comparative evaluation of advanced aerodynamic concepts for a 250,000-lb payload aircraft¹ are

Presented as Paper 78-95 at the AIAA 16th Aerospace Sciences Meeting, Huntsville, Ala., Jan. 16-18, 1978; submitted March 23, 1978; revision received July 31, 1978. Copyright © American Institute of Aeronautics and Astronautics, Inc., 1978. All rights reserved.

Index categories: Configuration Design, Aerodynamics; Performance.

*Study Manager, Associate Fellow AIAA.

†Senior Specialist Engineer.

‡Manager, Preliminary Design CTOL Aerodynamics. Member AIAA.

shown in Fig. 1. The baseline configuration utilized propulsion, structural, flight controls, and systems technology improvements projected for a 1985 design start while the aerodynamics technology was typical of Boeing 747 and Lockheed C-5A designs. Each aerodynamic concept was evaluated by performing only those design changes necessary to efficiently incorporate the concept into the reference configuration. Improvements in aerodynamic efficiency ML/D, reductions in takeoff gross weight (TOGW), and fuel savings for each concept are shown. Each evaluation included estimates of the system penalties incurred in incorporating the concept. The uncycled aerodynamic improvement corresponds to the aerodynamic improvement with the wing, engine, and tail sizes equal to the reference airplane. The uncycled airplane exceeds mission requirements due to the improved aerodynamics. The cycling or resizing design iteration produces the final aircraft sized to meet mission requirements. LFC individually produced an increase in ML/D of 27%, reduction in TOGW of 18%, and fuel savings of 29%, nearly double the improvement found for any of the aerodynamic concepts envisioned for the post-1990 IOC time frame. This evaluation of LFC is perhaps conservative, since the trailing-edge control areas were not laminarized; therefore, only about 60% of the wing and tail wetted area had laminar flow. It should be noted that performance benefits of the concepts are very dependent on the reference configuration, design mission, and assumed system penalties.

This comparative evaluation provided the impetus for the follow-on, more in-depth design study, described in the following, of LFC applications, and reassessment of the assumed system design penalties.

Turbulent Baseline Design

The baseline turbulent airplane shown in Fig. 2 was developed from the substantial Boeing data base of large freighter studies to meet the design mission objectives. The technology level assumes a start of prototype production in 1985, first flight about 1989, and an IOC after 1990. Selection of a three-bay fuselage was strongly dictated by the design payload requirements of either three M-60 tanks or 75 military pallets. Kneeling landing gear permits a cargo floor loading height of 84 in. The forebody cab features an advanced one-piece windshield compatible with body drag reduction techniques. The wing planform was selected for efficient long-range cruise performance, incorporating the benefits of active controls and advanced composites struc-

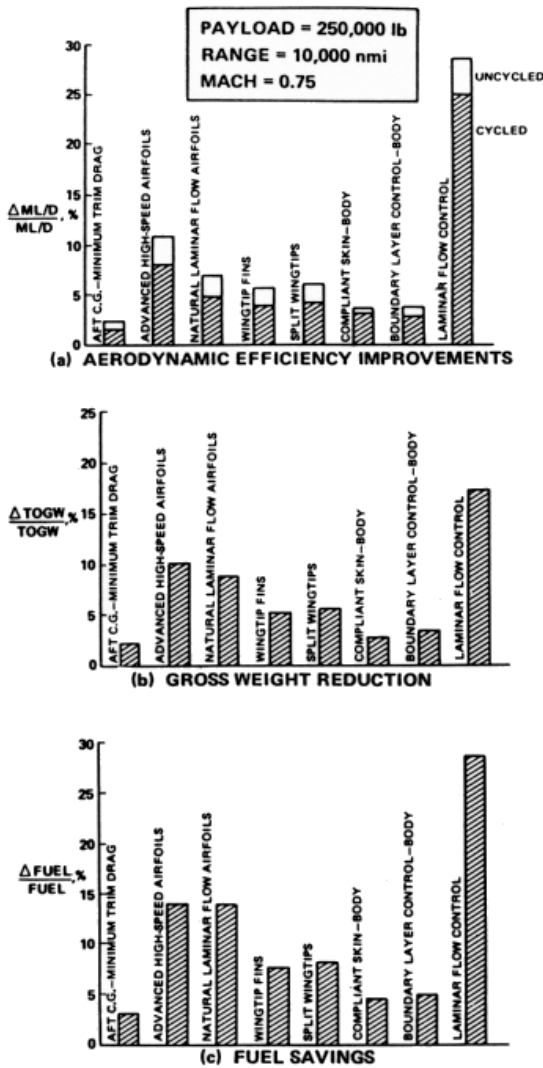

Fig. 1 Potential benefits of advanced aerodynamic concepts.

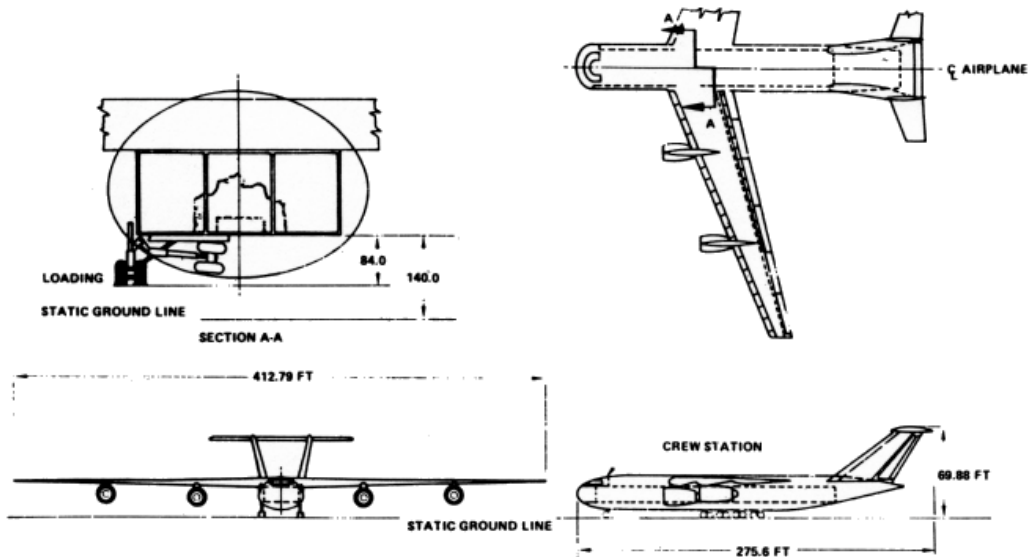

Fig. 2 Reference turbulent airplane.

tural materials. The high-lift system included 747 SP-type single-slotted trailing-edge flaps, and variable camber leading-edge flaps. The canted π tail empennage arrangement is a structurally efficient design that provides drive-through and air-drop capability. The propulsion system consists of four 1985-technology high-bypass ratio engines, located on the wing primarily because of airplane balance requirements. Spanwise locations were set by flutter considerations and provide wing bending relief. The design selection chart for the reference turbulent airplane is shown in Fig. 3. The design chart parametrically shows the effect of thrust/weight ratio (T/W) and wing loading (W/S) on airplane gross weight and block fuel requirements for an otherwise fixed configuration. Performance factors and constraints, such as takeoff field length (TOFL), initial cruise altitude capability (ICAC), and the ratio of the initial cruise lift coefficient capability to the lift coefficient for maximum lift/drag ratio ($C_{L,R}$) also are identified. The minimum gross weight turbulent airplane requires a high wing loading of approximately 160 lb/ft² and cannot meet the TOFL requirement. The minimum fuel-burned turbulent airplane requires a lower wing loading (110 lb/ft²) and does meet the takeoff field requirements of 9000 ft. The final design for the turbulent airplane was selected by considering the trade between fuel burned and gross weight along the TOFL = 9000 ft constraint line. The selected design, which has a wing loading of 112.7 lb/ft², almost matches the minimum fuel design, and has a gross weight only 2.3% above the minimum gross weight for this configuration.

LFC Wing Optimization

The LFC airplane shares common fuselage and empennage design features with the baseline turbulent airplane. The LFC wing was resized for optimum performance. Three wing structural design concepts resulting from Boeing in-house and NASA-sponsored studies were considered. An integrated-duct load-carrying structure was selected for the military configuration of this study. This concept offers the promise of lightweight, aerodynamically smooth structure with lower technical risk through design innovation. An integrated-duct load-carrying structural concept was used on the X-21 flight test airplane.

Wing and tail surfaces are slotted to provide laminarization to 70% chord, corresponding to the start of the trailing-edge control surfaces. Potential performance benefits of increasing the chordwise extent of laminarization are explored in the next section. Suction is provided by six ram-air turboshaft

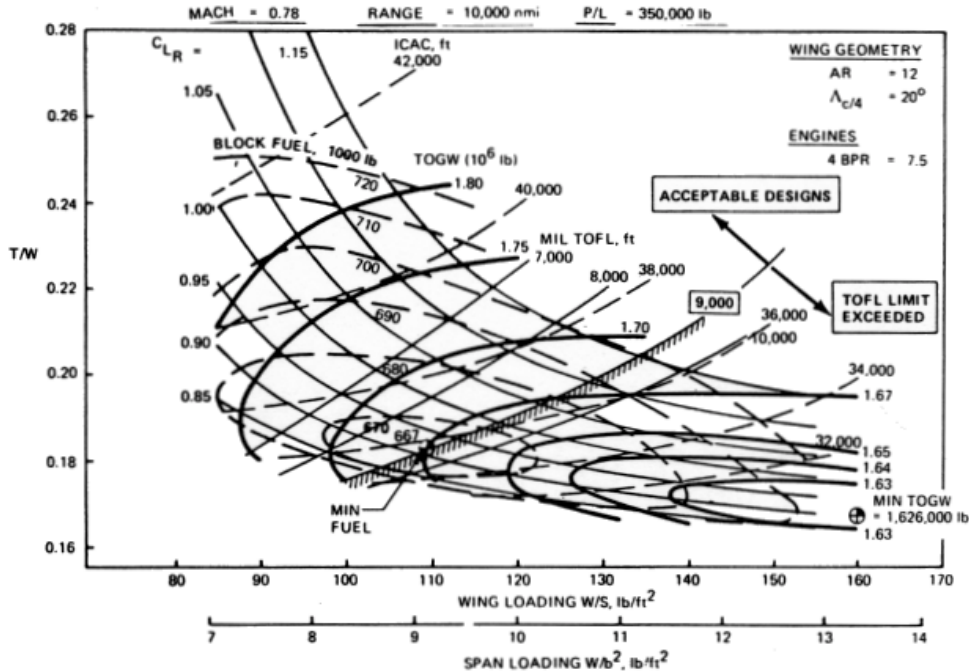

Fig. 3 Engine airframe matching for the reference turbulent airplane.

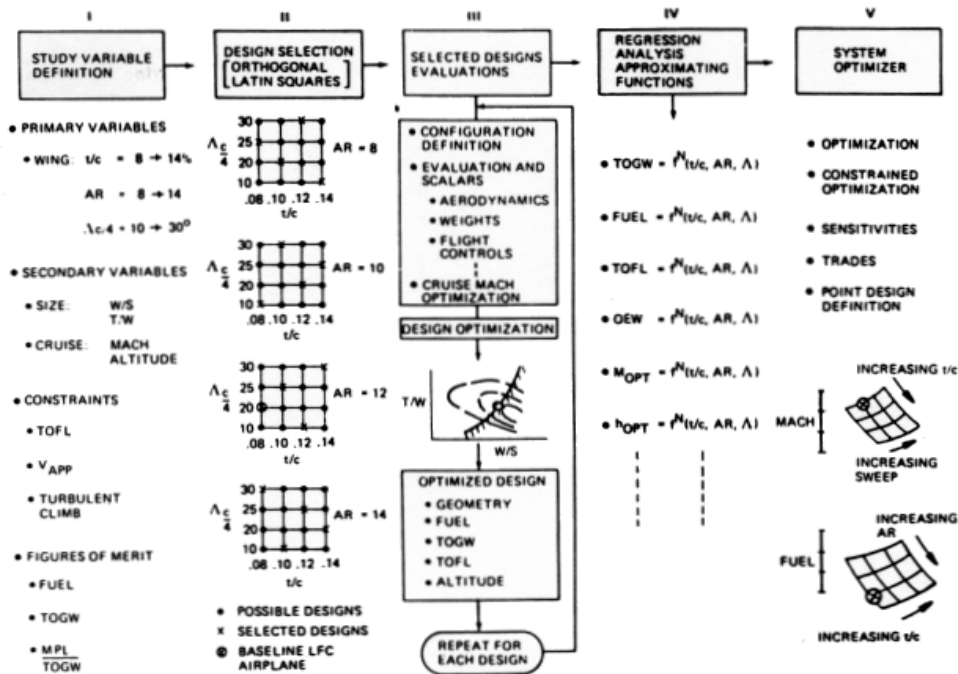
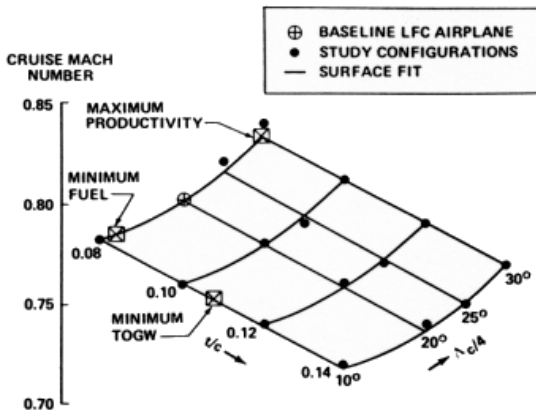

Fig. 4 Laminar flow control wing parametric optimization study.

engine/compressor units, two units located on each wing, and two units located on the empennage. Specific design criteria applied to the wing and empennage duct systems and resulting duct size and flow rates are contained in Ref. 2.

The preceding definition of the LFC systems and configuration provided the baseline airplane for a wing geometry/cruise speed optimization study. The technique used³ consists of the five sequential steps shown in Fig. 4. The range of values of the primary wing variables; i.e., thickness ratio (t/c), aspect ratio (AR), and quarter-chord sweep Λ , is

defined in step I. Since four values were specified for each of the three variables, there are 64 possible combinations. In step II, the method of orthogonal Latin squares was used to define a minimum number of wing designs (16) that accurately represent the entire matrix. In step III, each of the 16 selected designs was evaluated by the engine/airframe matching technique used to obtain Fig. 3. This process provided values of the secondary variables; i.e., wing loading (W/S), thrust to weight ratio (T/W), Mach number (M), and cruise altitude, that satisfy the design constraints. Values for the principal



constrained optimization studies, sensitivity studies, and trade studies.

Results of the wing planform/cruise speed optimization study illustrate the impact of wing planform geometry on the cruise Mach number (Fig. 5), fuel burned (Fig. 6), and TOGW (Fig. 7). The surface fit equations from the regression analysis are a good representation of the initial baseline LFC configuration and the additional 15 LFC configurations. The wing geometry (primary variables) and cruise Mach number for the resulting minimum fuel, minimum TOGW, and maximum productivity airplanes are shown in Table 1. Sensitivities of the airplanes to changes in the wing planform are also shown. Sensitivity is defined to be the total change in the primary figure of merit, e.g., fuel burned over the entire range of the particular design variable.

The optimum planform for the minimum fuel airplane has the highest aspect ratio, lowest thickness/chord ratio, and a quarter-chord sweep of about 12 deg. This results in a cruise Mach number of 0.78. The sensitivity data show that a high aspect ratio is the most important for minimum fuel (largest sensitivity coefficient in Table 1), wing thickness is of secondary importance, and sweep is rather unimportant.

The minimum gross weight airplane has the same maximum aspect ratio as the minimum fuel airplane, and a slightly lower sweep angle. This minimum gross weight airplane favors a higher thickness ratio of 11% and a corresponding optimum cruise Mach number of 0.75. The sensitivity data show that a low sweep angle and high aspect ratio are most important for

design figures of merit, i.e., fuel burned, takeoff gross weight, and productivity, were also calculated. A forward step regression analysis method was used in step IV to construct approximating functions to represent the relation between the primary independent and each dependent variable, including the constraints and figures of merit. Step V uses a powerful nonlinear optimizer on the constructed approximating functions to conduct constrained or un-

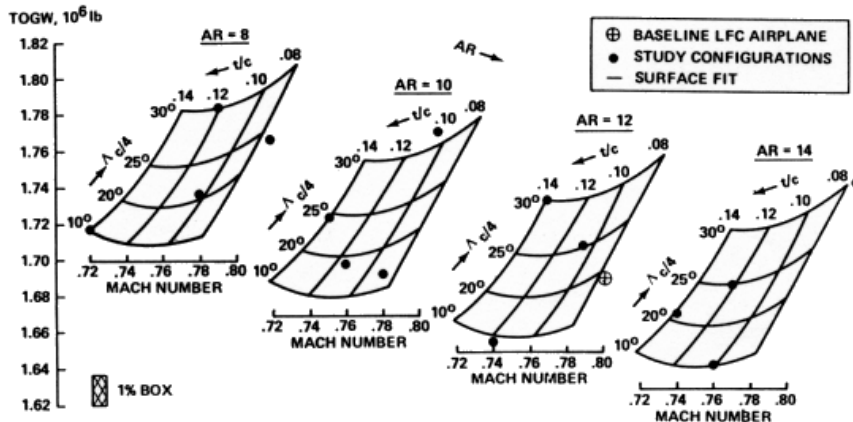
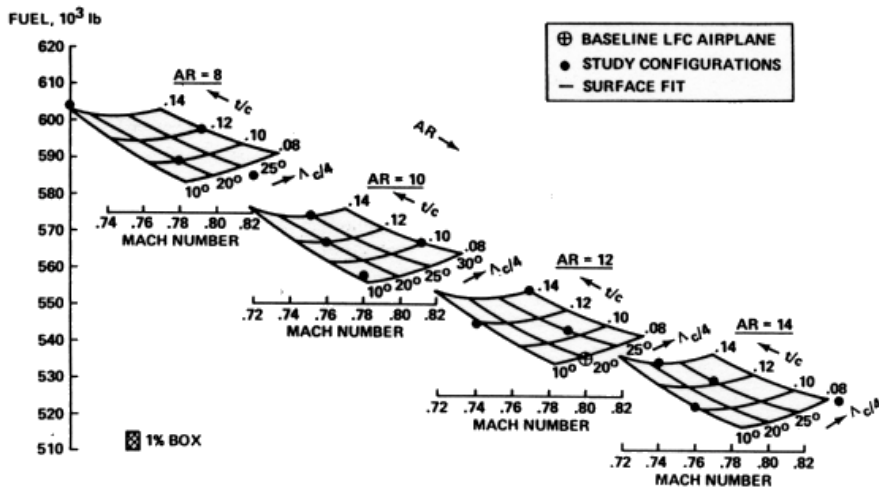

Table 1 Laminar flow control wing optimization study results

Optimum configurations	Primary figure of merit:	Design sensitivities		
		Change, %	Design variable range	
Minimum fuel A/P $M = 0.78$	$R = 14(\text{max})$	12.9	$R = 8 - 14$	
	$t/c = 0.08(\text{min})$	4.0	$t/c = 0.08 - 0.14$	
	$\Lambda_{c/4} = 11.6 \text{ deg}$	1.6	$\Lambda_{c/4} = 10 - 30 \text{ deg}$	
Minimum TOGW A/P $M = 0.75$	$R = 14(\text{max})$	4.0	$R = 8 - 14$	
	$t/c = 0.11$	0.6	$t/c = 0.08 - 0.14$	
	$\Lambda_{c/4} = 10 \text{ deg} (\text{min})$	5.1	$\Lambda_{c/4} = 10 - 30 \text{ deg}$	
Maximum $\frac{\text{MPL}}{\text{TOGW}}$ A/P $M = 0.84$	$R = 14(\text{max})$	3.6	$R = 8 - 14$	
	$t/c = 0.08(\text{min})$	6.6	$t/c = 0.08 - 0.14$	
	$\Lambda_{c/4} = 30 \text{ deg} (\text{max})$	1.4	$\Lambda_{c/4} = 10 - 30 \text{ deg}$	

the minimum gross weight airplane. Wing thickness ratio is an insignificant design variable in this case.

The maximum productivity airplane also favors the maximum aspect ratio. The optimum configuration for this case requires a high sweep and low wing thickness because productivity varies linearly with cruise speed. This results in a cruise Mach number of 0.85. The sensitivity data indicate that a low thickness ratio is most important, followed by aspect ratio and sweep, respectively, in importance.

A low-chord Reynolds number and a low-unit Reynolds number are desirable to ease the task of laminarization. The study airplanes all cruised at Mach number and altitude combinations such that the unit Reynolds number was 1.5×10^6 . Thus, higher aspect ratios are necessary to limit the maximum-chord Reynolds numbers. The attachment line momentum thickness Reynolds number, $R_{\theta_{AL}}$, is also an important parameter. If $R_{\theta_{AL}}$ exceeds about 100, disturbances may propagate spanwise along the LE, destroying laminar flow aft along the wing. Exceeding this limit would require special treatment, such as suction around the LE with chordwise slots or locally reduced LE radii as tested during the X-21 program. Low wing sweep is required to achieve low values of $R_{\theta_{AL}}$, and will also reduce boundary-layer crossflow instability problems.

Results of the wing planform/cruise speed optimization study summarized in Table 2 show that the desirable planforms for optimum performance also ease the task of laminarization. A wing planform having a high aspect ratio, low thickness/chord ratio, and low sweep minimizes both fuel and gross weight and maximizes productivity. The same geometry results in low-chord Reynolds number, crossflow, and attachment line Reynolds numbers. The wing planform

selected for the LFC configuration and shown in Fig. 8 has $R = 14$, $t/c = 0.14/0.08$, and $\Lambda_{c/4} = 10 \text{ deg}$.

Tradeoff Studies

Design of the final LFC airplane required qualitative assumptions in several key areas. Changes in the airplane and its cost, brought about by changes in these assumptions, are investigated in this section.

The LFC airplane was sized with a total LFC weight penalty of 2.25 lb/ft² based on the entire laminarized wetted area. This penalty includes the suction pumps, suction engines, main collector ducts and manifolds, surface structural integration, and installation penalties to the surrounding structure. This is not a validated weight level, but was considered reasonable for conducting the various studies. In order to identify the sensitivity of the LFC configuration to this assumption, total LFC system plus structural integration weight penalties of 0, 2.25 and 3.0 lb/ft² of treated wetted area were considered. The variation of fuel savings, TOGW reductions, and operator's empty weight (OEW) changes relative to the reference turbulent airplane are shown in Fig. 9. For the basic LFC weight penalty of 2.25 lb/ft² of laminarized area, the impact of LFC is: 27% fuel savings, 7% reduction in TOGW, and 12.2% increase in OEW. The increased OEW is primarily due to the higher optimum wing aspect ratio (14) of the LFC airplane as compared to the reference turbulent airplane ($R = 12$). The data also show that a reduction of $\frac{1}{2}$ lb/ft² in LFC weight penalty will produce additional fuel savings of 1%, TOGW reduction of 2%, and OEW reduction of 4%.

Effects of in-flight loss of LFC, or of failure to establish laminar flow, were investigated to determine the impact on

Table 2 Desirable laminar flow control wing planform characteristics

Figure of merit	Wing design parameter		
	Aspect ratio	Thickness ratio	Sweep
Minimum fuel	high	low	NMC
Minimum TOGW	high	NMC	low
Maximum $\frac{\text{MPL}}{\text{TOGW}}$	high	low	NMC
Low-chord Reynolds number	high	NMC	NMC
Low unit Reynolds number	NMC	NMC	NMC
Minimize cross flow	NMC	low	low
Minimize LE contamination	high	low	low

NMC: Not a major consideration.

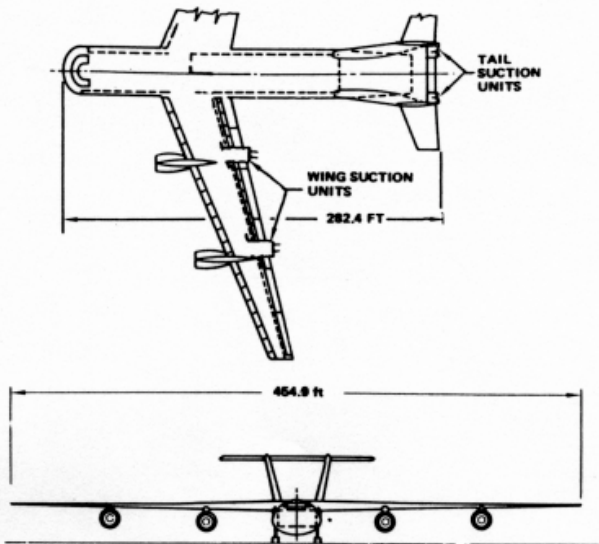
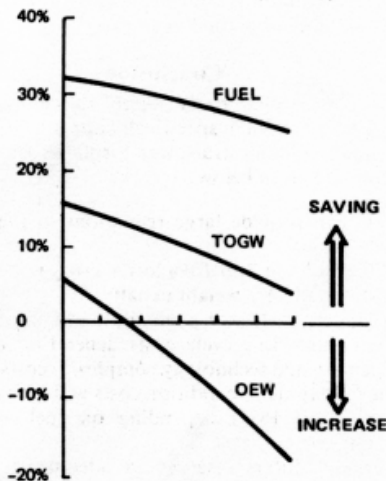

Fig. 8 Final laminar flow control airplane.



NOTE:
CHANGES RELATIVE TO REFERENCE
TURBULENT AIRPLANE

Fig. 9 Laminar flow control fuel and weight savings.

the mission performance of the airplane. With full loss of LFC, the cruise lift/drag ratio is reduced from 40 to 28 due to the increase in wing and tail profile drag. The normal reserves (5% mission fuel plus 30 min sea-level loiter) will allow the airplane to cruise 2000 nmi (or 5 h) with full loss of laminar flow to achieve the design laminarization and meet the 10,000-nmi mission. This capability is considered sufficient to fly out of a typical storm area. The reserves also allow the airplane to accomplish the design mission with a 25% loss of LFC over the entire mission.

The basic LFC airplane had the wing and empennage laminarized to 70% chord, primarily because of reduced design complexity and lower technical risk. Results of a recent advanced composites LFC wing design study⁴ indicate that full-chord laminarization of a wing with trailing-edge controls is technically feasible. The objective here was to assess potential performance benefits of increasing the chordwise extent of laminarization on the wing and empennage without consideration of the detailed design difficulties. The cruise lift/drag ratio increases from 40 to 46 as the extent of laminarization is increased from 70 to 95% chord. The associated penalties include increased LFC systems weight, doubled suction mass flow, and increased suction engine fuel requirements.

Figure 10 is a comparison of the gross weight of the LFC configuration, sized with different chordwise extents of laminar flow, and the gross weight of the reference turbulent airplane. The LFC configuration without laminar flow has a higher gross weight than the turbulent airplane because the optimum planform for the LFC configuration is not optimum for the reference turbulent airplane. The gross weight decreases as the laminarization is extended aft, due to the reduced fuel requirements. The effect of the extent of laminarization of fuel savings, TOGW, and OEW change shown in Fig. 10 suggests the following order for achieving maximum LFC benefits: 1) laminarize the wing back to the TE control surfaces; 2) laminarize the empennage back to minimum chord TE controls; and 3) conduct design studies to identify feasibility of laminarizing over the TE control surfaces.

Economic analyses were made to compare the 20-year life-cycle costs and surge condition operating costs of the LFC and turbulent configurations. Additional analyses were made to identify the sensitivity of the relative costs to fuel price, LFC total weight penalty, LFC technology complexity, and maintenance costs. The total fuel costs, at 40¢/gal, of the turbulent airplane are a small portion of the total life-cycle costs shown in Fig. 11 because of the low peacetime utilization rate of 1080 flying hours per airplane per year. Production costs are the major cost items. Although LFC reduced the fuel

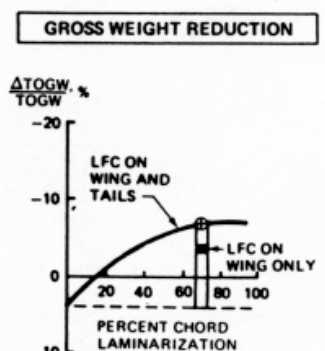
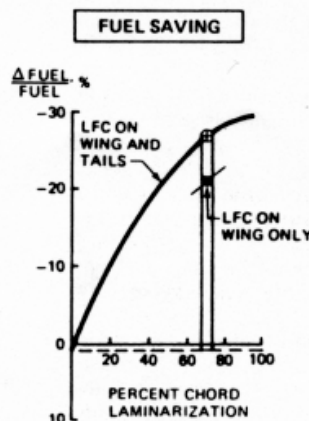
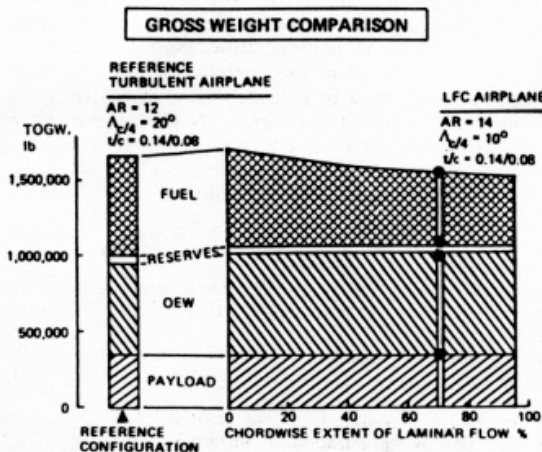

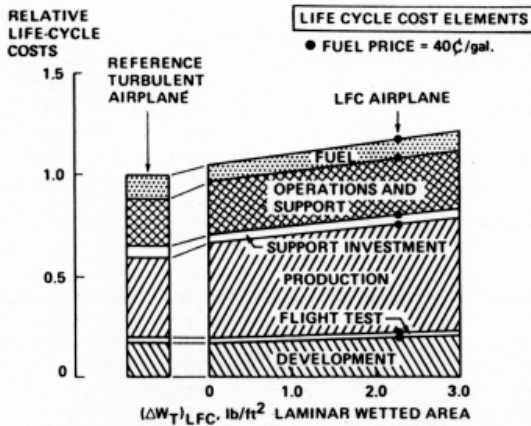

Fig. 11 Twenty-year life cycle cost elements.

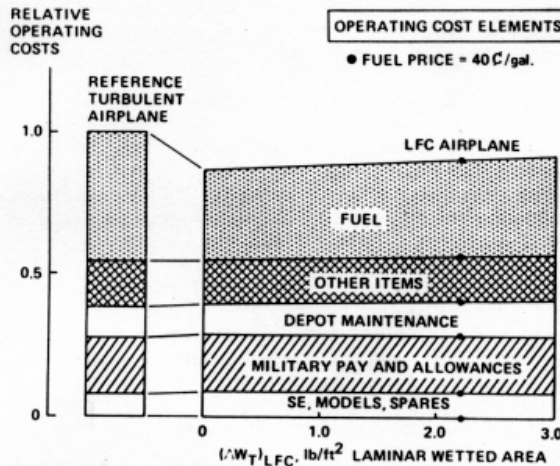

Fig. 12 The 60-day surge conditions cost elements.

costs significantly, the estimated production costs increased such that the relative life-cycle costs of the LFC airplane exceed those of the turbulent airplane by 16.5% for the 2.25 lb/ft² LFC weight penalty. Operating costs, shown in Fig. 12, were determined for a surge condition with a higher utilization rate of 10 flying hours per day per airplane for a 60-day period. For this case, fuel costs comprise a major portion of the operating costs. Consequently, operating costs of the LFC airplane are 9% (2.25 lb/ft² weight penalty) less than those of the turbulent airplane. Similarly, at 80¢/gal, the relative life-cycle costs and operating costs of the LFC airplane are, respectively, 13% more and 14% less than for the turbulent airplane.

The aforementioned economic assessments of the LFC airplane assumed a 3.5% increase in maintenance costs above a conventional turbulent airplane. LFC complexity costs reflect the estimated impact of LFC on engineering hours, development hours, tooling hours, and production hours. A 50% variation in technology complexity costs changes the life-cycle cost by 5%, and has a negligible effect on the surge condition operating costs. An increase in maintenance cost factor from 3.5 to 10% increases the life-cycle costs by 1.5% and the operating costs by 4%.

The relative life-cycle costs of the LFC airplane are shown in Fig. 13 for no increase in technology complexity costs above that of the turbulent airplane. This is a design objective for LFC airplanes. For this case, the life-cycle costs of the LFC airplane would be less than those of the turbulent airplane when the LFC system and structural weight penalty is less than 1.5 lb/ft².

Fuel savings that would be achieved through the use of laminar flow control are important. The 20-year peacetime

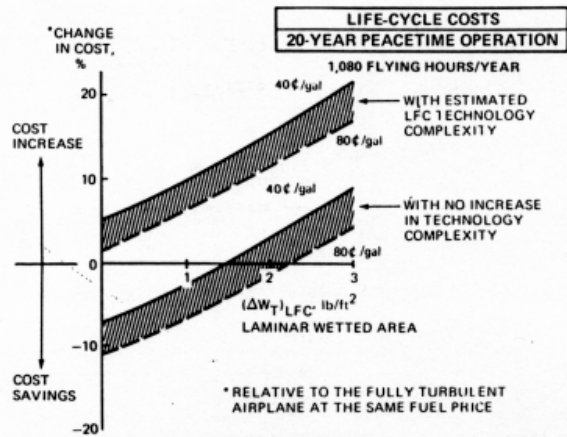

Fig. 13 Effect of technology complexity on relative laminar flow control life-cycle costs.

low-utilization rate would result in a fuel savings of over 2-billion gal of fuel. Additionally for every 60-day surge condition, the LFC airplane would save nearly 60-million gal of fuel. That amount is equivalent to the total fuel burned by 104,000 cars operating for 1 year.

Conclusions

Major conclusions based upon the assumptions made during this study, which specifically apply to very long-range, high-payload military transport airplanes of relatively low utilization, are given below.

- 1) LFC can provide large reductions in fuel usage (27 to 30%).
- 2) LFC results in 7 to 10% lower gross weights, depending on the estimated LFC weight penalty.
- 3) Life-cycle costs will probably be higher for low design utilization rates. Life-cycle costs depend on estimated LFC weight penalty and technology complexity costs.
- 4) The 60-day surge condition costs will be less with an LFC airplane (10 to 15%) depending on fuel price and LFC maintenance costs.
- 5) Normal military reserves are adequate to meet mission objectives with reasonable losses of LFC.
- 6) The LFC wing planform for optimum performance is beneficial to the task of providing LFC.
- 7) The extent of laminarization study has suggested an order for achieving LFC benefits with minimum technical risk.

The purpose of this study was to conduct a preliminary design investigation of a large subsonic military transport to identify the impact of laminar flow control on the performance and economics of the airplane. A valid assessment of an LFC airplane must be preceded by an extensive design, development, and flight test program. NASA, as part of the Aircraft Energy Efficient (ACEE) program, is conducting extensive LFC studies that currently include a flight test program to determine the operational and economic feasibility of LFC.

References

- ¹Kulfan, R.M. and Howard, W.M., "Application of Advanced Aerodynamic Concepts to Large Subsonic Transport Airplanes," AFFDL-TR-75-112, Nov. 1975.
- ²Kulfan, R.M. and Vachal, J.D., "Application of Laminar Flow Control to Large Subsonic Military Transport Airplanes," AFFDL-TR-76-65, July 1977.
- ³Healy, M.J., Kawalik, J.S., and Ramsay, J.W., "Airplane Engine Selection by Optimization on Surface Fit Approximations," *Journal of Aircraft*, Vol. 12, Sept. 1975, pp. 593-599.
- ⁴Swinford, G.R., "A Preliminary Design Study of a Laminar Flow Control Wing of Composite Materials for Long Range Transport Aircraft," NASA CR-144950, April 1976.